

Assembly Instructions for cable gland: 501/453/RAC

Operating temperature range -60°C +100°C

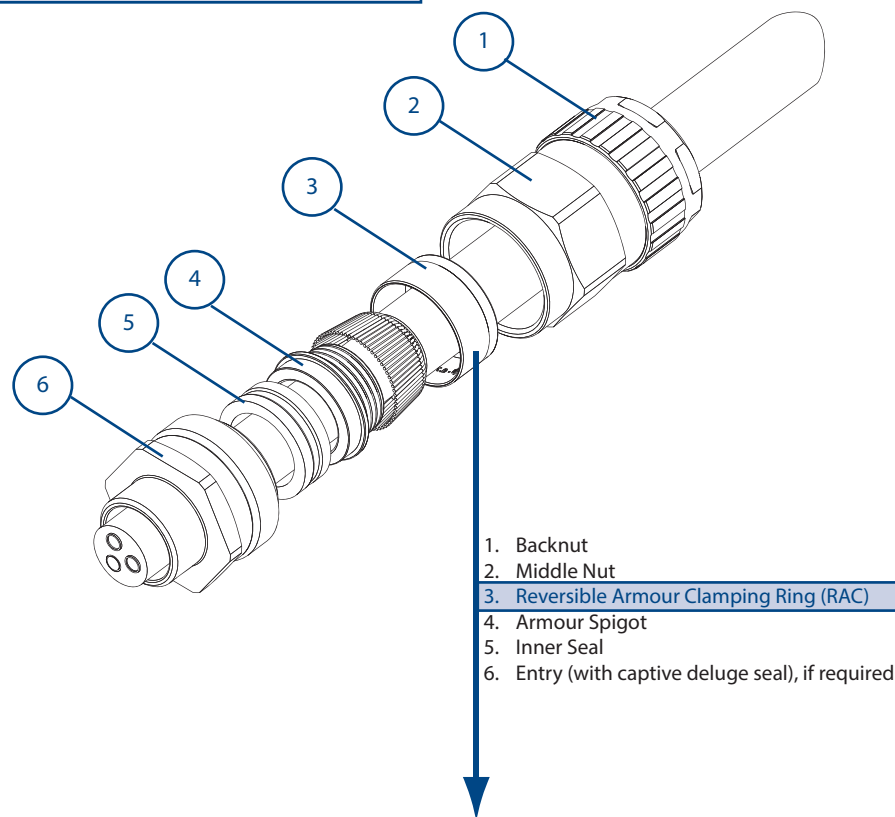

1. Backnut
2. Middle Nut
3. Reversible Armour Clamping Ring (RAC)
4. Armour Spigot
5. Inner Seal
6. Entry (with captive deluge seal), if required

Certification Details

Gland Type: 501/453/RAC
 Exdb IIC Gb, Exeb II Gb, Extb IIIC Db
 Baseefa06ATEX0056X (Ex) II 2 GD IP66 CE
 IECEx BAS06.0013X
 IEx 14.0272X
 EAC TC RU C-GB.IT505.B.00750
 c CSA us No: 1015065
 Class 1 Zone 1 AExd IIC, AExe II,
 Zone 21 AExtD
 Class 1 Div 2 ABCD, Class II Div 2 Groups EFG, Class III
 CNEx07.3449X

Reversible Armour Clamping Ring (RAC)

General identification ring orientation for:

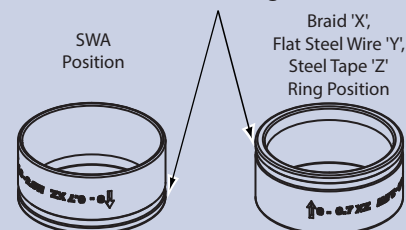

IMPORTANT: The arrowhead indicating the correct armour thickness or type should point towards the equipment

Note: Cable acceptance sizes are marked on the diaphragm seal, clamping ring and backnut.

Cable Preparation

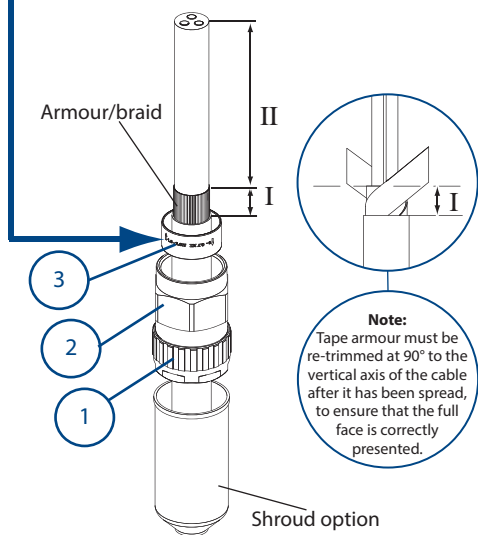

A Strip Cable to suit equipment as shown above and expose the armour/braid 'I'.
 'I' = 20mm for cable gland sizes Os to C
 'I' = 25mm for cable gland sizes C2 to F
 'II' = to suit equipment.
 If required, fit shroud.

Gland Preparation

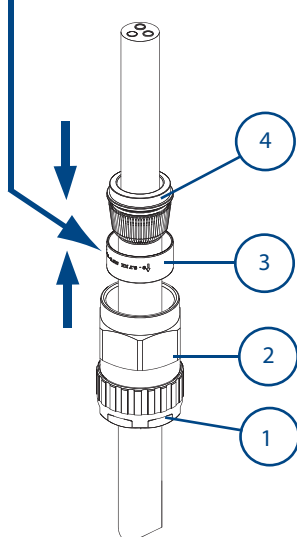

B Push the cable through the armour spigot ④. Spread armour/braid over the armour spigot ④ until the end of the armour/braid is up against the shoulder of the armour cone. Position the armour clamping ring ③.

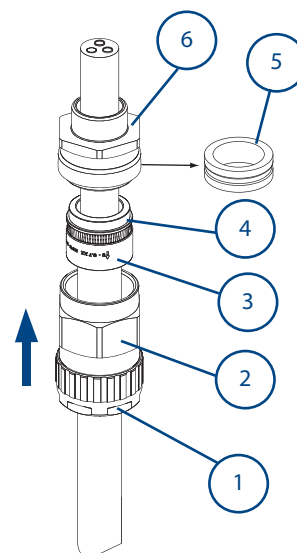

C Remove the inner seal ⑤ from the entry ⑥. Place the entry ⑥ over the armour spigot ④. Move the sub-assembly ① and ② up to meet the entry ⑥.

Note: If the equipment has a threaded entry, it may be advisable to screw the entry component into the equipment to prevent twisting of the cable after step D

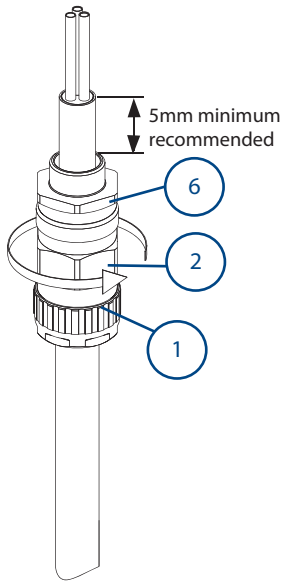

D
Unless already screwed into the equipment hold the entry ⑥ in position with a spanner/wrench to prevent rotation. Hand tighten the middle nut ② to the entry ⑥ and turn a further half to one full turn with a spanner/wrench.

IMPORTANT: Support the cable to prevent it from twisting. To ease wiring inside the enclosure, it may be beneficial to strip the inner sheath of the cable as shown above.

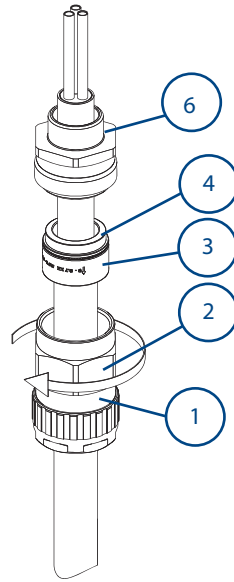

E
Unscrew the middle nut ② and visually inspect that the armour/braid has been successfully clamped between the armour spigot ④ and the armour clamping ring ③. If armour/braid not clamped, repeat assembly.

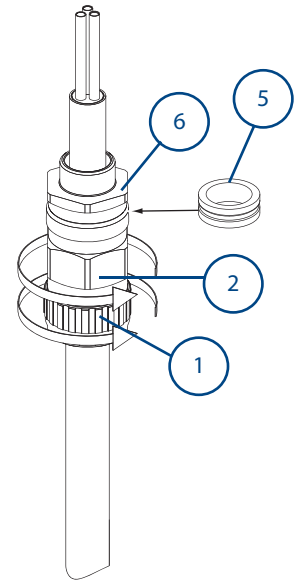

F
Remove entry ⑥ and refit inner seal ⑤, replace entry ⑥ and re-assemble middle nut ② onto the entry component ⑥. Tighten up the middle nut ② by hand then using a wrench/spanner a further 1 to 2 turns until fully tight.

Note: Two full turns may not be possible on cables at the top of the cable gland acceptance range.

Tighten the backnut ① to form a seal around the cable, then tighten a further full turn using a wrench/spanner. Ensure that the middle nut ② does not rotate when tightening the backnut ①. Ensure that the deluge seal is pulled down into position, if fitted. Locate the shroud over the cable gland, if applicable.

CABLE GLAND SELECTION TABLE

Size Ref.	Entry Thread Size		Cable Acceptance Details								Compressed Length	Maximum Length	Hexagon Dimensions	
			Inner Sheath				Outer Sheath		Steel Wire Armour/Tape/Braid					
	Standard Seal		Alternative Seal (S)		Orientation 1	Orientation 2								
	Metric	NPT	Min.	Max.			Min.	Max.	Min.	Max.			Across Flats	Across Corners
Os	M20 [*]	½"	3.2	8.0	---	---	5.5	12.0	0.8/1.25	0/0.8	52.0	79	24.0	26.5
O	M20 [*]	½"	6.5	11.9	---	---	9.5	16.0	0.8/1.25	0/0.8	52.0	79	24.0	26.5
A	M20	½" - ¾"	10.0	14.3	9.0	13.4	12.5	20.5	0.8/1.25	0/0.8	53.0	79	30.0	32.5
B	M25	¾" - 1"	13.0	20.2	9.5	15.4	16.9	26.0	1.25/1.6	0/0.7	59.5	95	36.0	39.5
C	M32	1" - 1¼"	19.5	26.5	15.5	21.2	22.0	33.0	1.6/2.0	0/0.7	64.0	95	46.0	50.5
C2	M40	1¼" - 1½"	25.0	32.5	22.0	28.0	28.0	41.0	1.6/2.0	0/0.7	68.3	98	55.0	60.6
D	M50	1½" - 2"	31.5	42.3/44.4	27.5	34.8	36.0	52.6	1.8/2.5	0/1.0	79.0	126	65.0	70.8
E	M63	2" - 2½"	42.5	54.3/56.3	39.0	46.5	46.0	65.3	1.8/2.5	0/1.0	78.4	130	80.0	88.0
F	M75	2½" - 3"	54.5	65.3/68.2	49.5	58.3	57.0	78.0	1.8/2.5	0/1.0	83.7	128	95.0	104.0
G [^]	M80	3½"	67.0	73.0	N/A	N/A	75.0	89.5	2.0/3.5	0/1.0	95.6	131	106.4	115.0
H [^]	M90	3½"	67.0	77.6	N/A	N/A	75.0	89.5	2.0/3.5	0/1.0	95.6	131	115.0	130.0
J [^]	M100	4"	77.0	91.6	N/A	N/A	88.0	104.5	2.5/4.0	0/1.0	95.6	141	127.0	142.0

* Sizes Os and O are available with an M16 thread size. If M16 entry is used on O size cable glands the maximum cable inner sheath diameter is limited to 10.9mm.

[^] G, H & J sizes ATEX / IECEx Only

ACCESSORIES:

Before cable gland assembly or stripping of the cable gland assembly, consideration should be given to any cable gland accessories that may be required, such as: -

- Shroud, to offer additional corrosion protection.
- Locknut, to secure cable glands into position.
- Sealing washer, to offer additional ingress protection of the enclosure at the cable gland entry.
- Earthtag, to provide an external armour / braid bonding point.
- Serrated washer, to dampen any vibrations that may loosen the locknut or cable gland assembly.

SCHEDULE OF LIMITATIONS - Baseefa ATEX / IECEx:

1. The cable glands when used with braided cable types are only suitable for use with fixed apparatus, the cable for which must be effectively clamped and cleated elsewhere.
2. This cable gland has an operating temperature range of -60°C to +100°C.
3. A seal must be formed between the equipment and the cable gland to maintain the appropriate degree of protection against ingress of dust, solid objects and water.

NOTES - c CSA us:

1. The cable used must have extruded sealing (solid polymeric) completely surrounding the "core" (insulation and conductor), allowing for no holes or ventilation through the inner jacket or along the cores.
2. The 501/4** series cable gland connectors, when used in Class 1 Division 2 Classified areas, are not suitable to be interfaced with an explosion proof enclosure containing arcing and sparking devices, unless installed in conjunction with an approved explosion proof sealing fitting.
3. These glands are suitable for use with Certified Marine Shipboard armoured / unarmoured cables constructed to CSA Standard 245 and IEEE45 / IEC 600092-353 Standards, or certified equivalent), for use on Shipboards and Offshore Rigs / Platforms.
4. Must comply with Canadian Electrical Code and National Electric Code requirements for threaded entries.
5. For Exe applications, a sealing washer or thread sealant may be required between the enclosure and the gland to maintain the IP rating of the enclosure.
6. When used with unarmoured or braided cables the glands are only suitable for use with fixed apparatus and the cable must be effectively clamped and cleated elsewhere.
7. This cable gland may only be installed when temperature is above -5°C. After completion of the installation, the assembly is then suitable for -60°C to +100°C.

EU Declaration of Conformity in accordance with European Directive 2014/34/EU

Manufacturer: Hawke International

Address: Oxford Street West, Ashton-under-Lyne, OL7 0NA, United Kingdom.

Equipment: Group II Compression Cable Glands Type: 501/453/RAC

Provisions of the Directive fulfilled by the Equipment: Group II Category 2GD Exeb IIC Gb, Exdb IIC Gb, Extb IIIC Db – IP66

Notified Body for EU-Type Examination: SGS-Baseefa 1180 Buxton UK

EU-type Examination Certificate: Baseefa06ATEX0056X

Notified Body for production: SGS-Baseefa 1180 Buxton UK

Harmonised Standards used: EN 60079-0:2012+A11:2013, EN60079-1:2014, EN60079-7:2015, EN60079-31:2014.

On behalf of the above named company, I declare that, on the date the equipment accompanied by this declaration is placed on the market, the equipment conforms with all technical and regulatory requirements of the above listed directives.

.....
A. Tindall
Technical Manager