



Flashing beacon and Continuous beacon

Series 6161



Contents

1	General Information	2
1.1	Manufacturer	2
1.2	Information Regarding the Operating Instructions	3
1.3	Further Documents	3
1.4	Conformity with standards and regulations	3
2	Explanation of the Symbols	3
2.1	Symbols in these Operating Instructions	3
2.2	Warning Notes	4
2.3	Symbols on the Device or in the Circuit Diagrams	4
3	Safety Notes	5
3.1	Operating Instructions Storage	5
3.2	Safe Use	5
3.3	Modifications and Alterations	5
4	Function and Device Design	5
4.1	Function	5
5	Technical Data	6
6	Transport and Storage	7
7	Mounting and Installation	8
7.1	Dimensions / Fastening Dimensions	8
7.2	Mounting / Dismounting, Operating Position	9
7.3	Installation	10
8	Commissioning	10
9	Operation	11
9.1	Operation	11
9.2	Troubleshooting	11
10	Maintenance and Repair	11
10.1	Maintenance	11
10.2	Repair	12
10.3	Returning the Device	13
11	Cleaning	13
12	Disposal	13
13	Accessories and Spare Parts	13
14	Other	14
14.1	EC Declaration of Conformity	14

1 General Information

1.1 Manufacturer

R. STAHL Schaltgeräte GmbH
Kompetenzcenter Licht
Nordstr. 10
99427 Weimar
Germany

T +49 3643 4324
F +49 3643 4221-76
www.stahl-ex.com

R. STAHL Schaltgeräte GmbH
Am Bahnhof 30
74638 Waldenburg
Germany

T +49 7942 943-0
F +49 7942 943-4333
www.stahl-ex.com

1.2 Information Regarding the Operating Instructions

ID-No.: 120788 / 6161602300
 Publication Code: 2014-02-19-BA00-III-en-03

The original instructions are the English edition.
 They are legally binding in all legal affairs.

1.3 Further Documents

- Data sheet

For further languages, see www.stahl-ex.com.

1.4 Conformity with standards and regulations

The equipment conforms to the following standards:





- IEC 60079-0:2011, Edition 6.0
- IEC 60079-1:2007-04, Edition 6.0
- IEC 60079-7:2006-07, Edition 4.0
- IEC 60079-31:2008, Edition 1.0

Additional standards:

See certificates and EC Declaration of Conformity: www.stahl-ex.com.

2 Explanation of the Symbols



2.1 Symbols in these Operating Instructions

Symbol	Meaning
	Tips and recommendations on the use of the device
	General danger
	Danger due to explosive atmosphere
	Danger due to energised parts





2.2 Warning Notes

Warning notes must be observed under all circumstances, in order to minimize the risk due to construction and operation. The warning notes have the following structure:

- Signalling word: DANGER, WARNING, CAUTION, NOTICE
- Type and source of danger/damage
- Consequences of danger
- Taking countermeasures to avoid the danger/damage

	DANGER
	Danger for persons Non-compliance with the instruction results in severe or fatal injuries to persons.
	WARNING
	Danger for persons Non-compliance with the instruction can result in severe or fatal injuries to persons.
	CAUTION
	Danger for persons Non-compliance with the instruction can result in minor or light injuries to persons.
NOTICE	
Avoiding material damage Non-compliance with the instruction can result in material damage to the device and/or its environment.	

2.3 Symbols on the Device or in the Circuit Diagrams

Symbol	Meaning
 <small>05594E00</small>	CE marking according to the current applicable directive.
 <small>02198E00</small>	According to marking, device approved for hazardous areas.
 <small>15649E00</small>	Input
 <small>15648E00</small>	Output

3 Safety Notes

3.1 Operating Instructions Storage

- Read the operating instructions carefully and store them at the mounting location of the device.
- Observe applicable documents and operating instructions of the devices to be connected.

3.2 Safe Use

- Read and observe the safety notes in these operating instructions!
- Use the device in accordance with its intended and approved purpose only!
- We cannot be held liable for damage caused by incorrect or unauthorized use or by non-compliance with these operating instructions.
- Before installation and commissioning, make sure that the device is not damaged!
- Work on the device (installation, maintenance, overhaul, repair) may only be carried out by appropriately authorized and trained personnel.

3.3 Modifications and Alterations

	WARNING
	<p>Danger due to modifications and alterations to the device! Explosion protection is impaired!</p> <ul style="list-style-type: none"> • Do not modify or change the device. • No liability or warranty for damage resulting from modifications and alterations.

4 Function and Device Design

	WARNING
	<p>Danger due to improper use! Explosion protection is impaired!</p> <ul style="list-style-type: none"> • The device may only be used according to the operating conditions described in these operating instructions. • Use the device in hazardous areas only according to these operating instructions.

4.1 Function

Product series 6161 provides a visual signal intended to alert, warn or draw attention to an event. It is designed for use in potentially explosive gas and dust environments or areas of harsh environmental conditions. The product variants can be used in ATEX and IECEx zones 1,2 and 21, 22.

5 Technical Data

Explosion protection

Version	6161/2 Flashing Beacon	6161/3 Continuous Beacon
Global (IECEX)		
Gas and dust	IECEx LCI 08.0032X Ex d e IIC T* Gb -40°C T _{amb} +**°C Ex tb IIIC T* Db IP66 -40°C T _{amb} +**°C IEC 60079-0 : 2011 IEC 60079-1 : 2007-04 IEC 60079-7 : 2006-07 IEC 60079-31 : 2008 ** see ambient conditions for the temperature class	
Europe (ATEX)		
Gas and dust	LCIE 02 ATEX 6062 X Ⓢ II 2 G Ex d e IIC T* Gb -40°C T _{amb} +**°C Ⓢ II 2 D Ex tb IIIC T* Db IP66 -40°C T _{amb} +**°C EN 60079-0 : 2012 EN 60079-1 : 2007 EN 60079-7 : 2007 EN 60079-31 : 2009 Conditions of certificate: If wire guard is not installed, the apparatus shall be submitted to low mechanical impact only. ** see ambient conditions for the temperature class	
Certifications and certificates		
Certificates	IECEX, ATEX, China (China-Ex), India (PESO), Kazakhstan (GOST K), Russia (GOST R), Serbia (SRPS), Ukraine (TR), Belarus (operating authorisation)	IECEX, ATEX, China (China-Ex), Kazakhstan (GOST K), Serbia (SRPS), Ukraine (TR), Belarus (operating authorisation)
Ship approval	GL, RS	–
Conformity	CE 0158 according to 94/9/CE	CE 0158 according to 94/9/CE
Marine applications		
GL	50 881 - 04 HH	–
RS	11210000	–

Technical data

Version	6161/2 Flashing Beacon	6161/3 Continuous Beacon
Electrical data		
Rated values	24 ... 42 V AC 50 ... 60 Hz 0.5 ... 0.3 A 110 ... 127 V AC 50 ... 60 Hz 0.11 A 230 V AC 50 ... 60 Hz 0.08 A 12 ... 48 V DC 0.5 ... 0.3 A 60 ... 80 V DC 0.13 ... 0.11 A	24 V AC / DC 0 Hz, 50 ... 60 Hz 0.12 A 230 V AC 50 ... 60 Hz 0.02 A
Back-up fuse	4 AT (Fuse slow-blow or automatic circuit breaker C characteristic)	

Technical data**Luminous characteristics**

Flashing energy	5 Joules	–
Flashing frequency	1 Hz	–
Duty cycle	100%	100%
Service life	6 x 10 ⁶ flashes	–

Ambient conditions

Ambient temperature	** Temperature Class				** Temperature Class			
	Type	T _{amb}	Gas	Dust	Type	T _{amb}	Gas	Dust
	6121/2	+40 °C	T6	T85 °C	6121/3	+40 °C	T6	T65 °C
		+50 °C	T5	T100 °C		+50 °C	T6	T75 °C

Mechanical data

Degree of protection	IP66 according to IEC/EN 60529
Protection class	I (internal and external PE connection terminal according to IEC/EN 60598)
Material	
Enclosure	aluminium alloy copper-free, yellow/black powder-coated
Light dome	polycarbonate, prismatic
Wire guard	stainless steel
Fixing elements	stainless steel
Sealing ring	NBR-O-ring seal
Special lock	Ex d enclosure; M4 hexagon socket stud

Mounting / Installation

Cable entries	1 x M20 x 1.5 stopping plug 1 x M20 x 1.5 cable gland metal cable gland on request
Clamping range	6 ... 13 mm
Connection type	screw terminal block, 3-pole
Marking	L1 + N + PE
Connection cross-section	
solid	2 x 4 mm ²
finely stranded	2 x 2.5 mm ²
Protective conductor connection	
Inside	max. 6 mm ²
Outside	max. 2.5 mm ² flexible / 4 mm ² rigid

For further technical data, see www.stahl-ex.com.

6 Transport and Storage

- Transport and store the device only in the original packaging.
- Store the device in a dry place (no condensation) and vibration-free.
- Do not drop the device.

7 Mounting and Installation

7.1 Dimensions / Fastening Dimensions

Dimensional Drawings (All Dimensions in mm [inch]) – Subject to Alterations

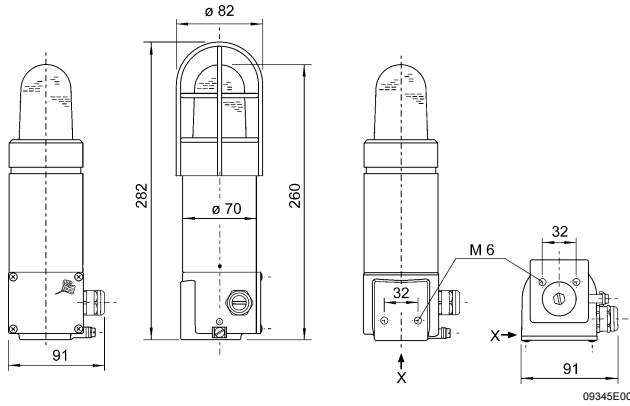

Flashing beacon 6161

Mounting accessories

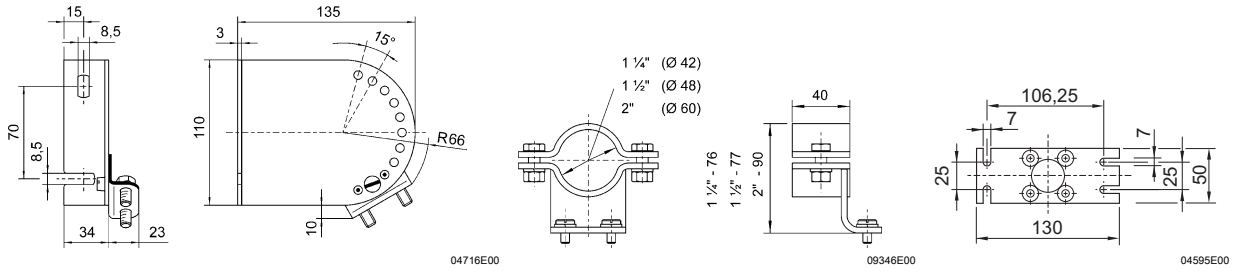

Ceiling and wall-mounting bracket

Pipe clamp

Mounting plate

7.2 Mounting / Dismounting, Operating Position

7.2.1 Installation with Mounting Plate

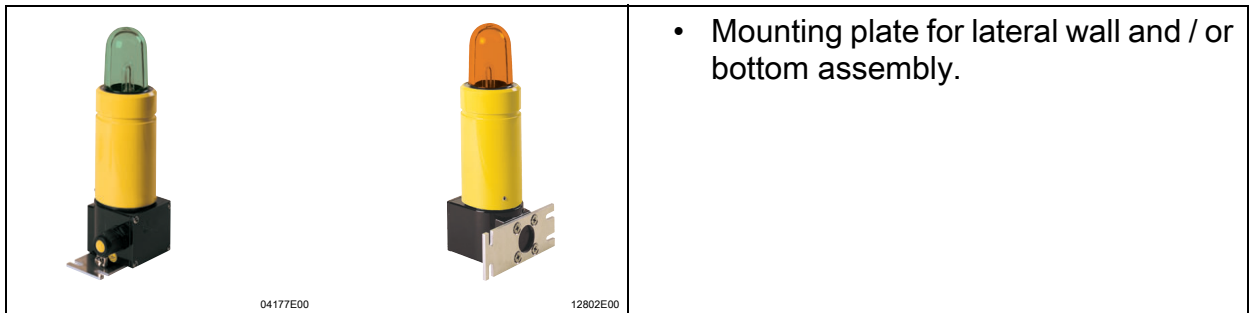

7.2.2 Installation with Pipe Clamp

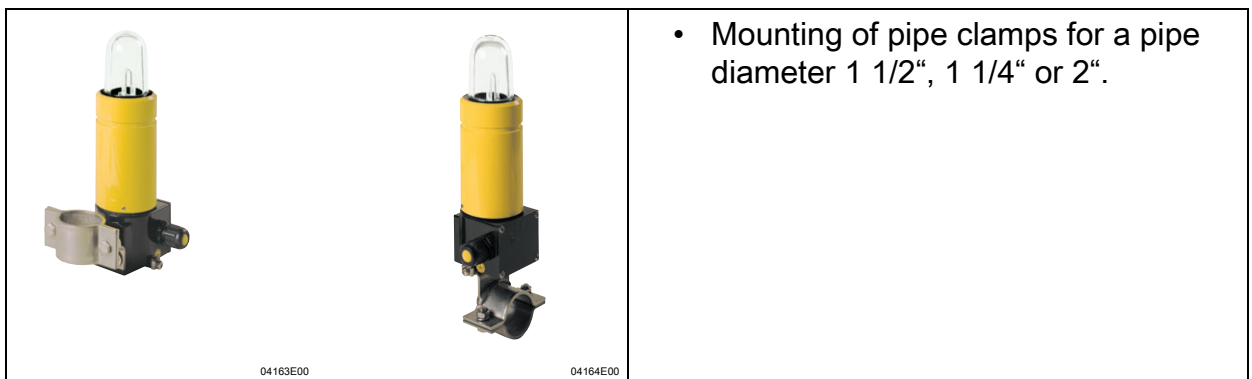

7.2.3 Installation with Mounting Bracket

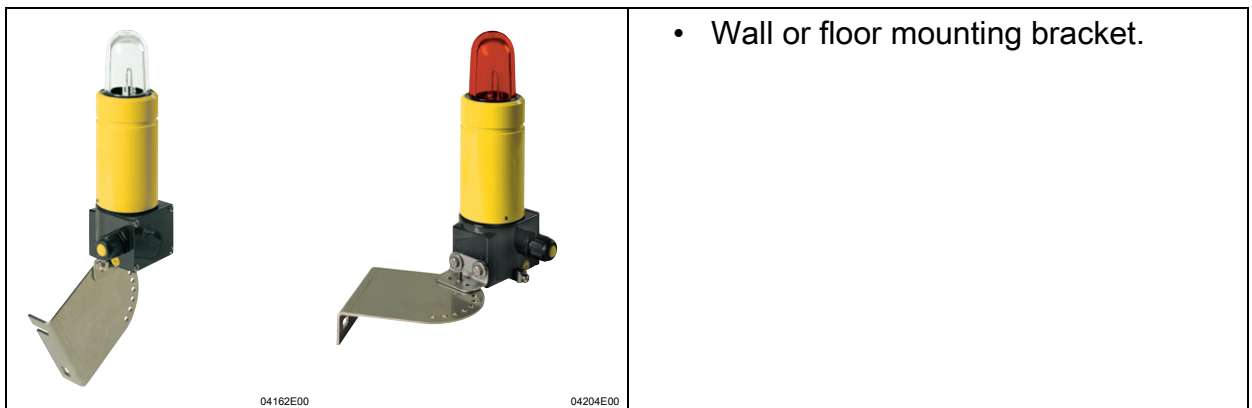

	<p>See datasheet for part numbers and ordering information.</p>
--	---

7.3 Installation

WARNING	
	<p>Danger due to live components! Risk of severe injuries!</p> <ul style="list-style-type: none"> • All connections and wiring must be disconnected from the power supply. • Secure the connections against unauthorized switching.

Electrical Connection

- Clamping must be carried out precisely!
- Do not clamp any part of the conductor insulation!
- Do not interchange the conductors!
- Observe the technical regulations when connecting the conductor!
- Clamp the conductor firmly!

	<p>Two conductors can be installed under one connection terminal. Material and cross-section of both conductors must be identical. The conductors can be connected without any special preparations.</p>
---	--

8 Commissioning

WARNING	
	<p>Check the device before commissioning! Explosion protection is impaired!</p> <ul style="list-style-type: none"> • Observe the inspection requirements in the current national regulations before commissioning in order to maintain the explosion protection. • Check the device for proper installation and function before commissioning.

Before commissioning, ensure that

- the device has been installed according to regulations.
- the power supply voltage and the rated operational voltage are identical.
- the required cable diameter for cable glands has been used.
- the cable entries and stopping plugs have been securely tightened.
- the cables are correctly connected.
- the connection has been performed correctly.
- all screws and nuts are tightened according to regulations.
- the connection chamber is clean.
- the device is not damaged.
- no foreign bodies are inside the device.
- the device is sealed according to regulations.

9 Operation

9.1 Operation

Product series 6161 provides a visual signal intended to alert, warn or draw attention to an event.

9.2 Troubleshooting

If an error occurs please re-visit the earlier sections of this document.

If the error cannot be eliminated using the mentioned procedures:

- Contact the local representative of R. STAHL Schaltgeräte GmbH.



For fast processing, have the following information ready:

- Type and serial number
- Purchase information
- Error description
- Intended use (in particular input / output wiring)

10 Maintenance and Repair

	WARNING
	<p>Unauthorized work being performed on the device! Risk of injuries and material damage!</p> <ul style="list-style-type: none"> • Work performed on the device must only be carried out by appropriately authorized and trained personnel.

10.1 Maintenance

	WARNING
	<p>Danger due to live components! Risk of severe injuries!</p> <ul style="list-style-type: none"> • All connections and wiring must be disconnected from the power supply. • Secure the connections against unauthorized switching.
	<p>Observe the relevant national regulations in the country of use.</p>

- Consult the relevant national regulations to determine the type and extent of inspections.
- Adapt inspection intervals to the operating conditions.

The following tests and measures must be carried out during regular maintenance.

Check	Measures
the permissible ambient temperature	If exceeding the permissible ambient temperature or falling below the device must be taken out of operation.
the enclosure components for formation of cracks and damage.	Replace the exchangeable enclosure components. If the enclosure components are non-exchangeable, the device must be taken out of operation.
its intended use	If the device is not used according to its intended use, it must be taken out of operation.
if the conductors are clamped properly the cables for ageing and damage	Clamp loose conductors tightly. Replace damaged or aged cables.
if the surface of the flameproof Ex-joint is damaged	If the flameproof Ex-joint is damaged, the device must be taken out of operation.
if corrosion on the flameproof Ex-joint is present	Apply acid-free grease, which is compatible with aluminium, to the flameproof Ex-joint.
if the safety screw M4 has been tightened firmly	Tighten the safety screw to a torque of 1.3 Nm.
if the external equipotential bonding conductor (as required) is still connected	Reconnect the external equipotential bonding conductor.
if the mounting screws have been tightened firmly	Firmly tighten the mounting screws.

10.2 Repair

	DANGER
	<p>Danger due to improper maintenance/repair! Explosion protection is impaired!</p> <ul style="list-style-type: none"> • Repair work on the device must be performed only by R. STAHL Schaltgeräte GmbH.

10.3 Returning the Device

Use the "Service form" to return the device when repair/service is required.

On the internet site "www.stahl-ex.com" under "Downloads > Customer service":

- Download the service form and fill it out.
- Send the device along with the service form in the original packaging to R. STAHL Schaltgeräte GmbH.

11 Cleaning

- Clean the device only with a cloth, brush, vacuum cleaner or similar items.
- When cleaning with a damp cloth, use water or mild, non-abrasive, non-scratching cleaning agents.
- Do not use aggressive detergents or solvents.

12 Disposal

- Observe national and local regulations and statutory regulation regarding disposal.
- Separate materials when sending it for recycling.
- Ensure environmentally friendly disposal of all components according to the statutory regulations.

13 Accessories and Spare Parts

NOTICE

Use only original accessories and spare parts by R. STAHL Schaltgeräte GmbH.



For accessories and spare parts, see data sheet on our homepage www.stahl-ex.com.

14 Other

14.1 EC Declaration of Conformity

EG-Konformitätserklärung
EC Declaration of Conformity
Déclaration de Conformité CE



R. STAHL Schaltgeräte GmbH • Am Bahnhof 30 • 74638 Waldenburg, Germany
 erklärt in alleiniger Verantwortung, declares in its sole responsibility, déclare sous sa seule responsabilité,

dass das Produkt: Signalleuchte
 that the product: Strobe signal light
 que le produit: Lampe à éclats

Typ(en), type(s), type(s): 6161/...-...-

mit den Anforderungen der folgenden Richtlinien und Normen übereinstimmt.
 is in conformity with the requirements of the following directives and standards.
 est conforme aux exigences des directives et des normes suivantes.

Richtlinie(n) Directive(s) Directive(s)	Norm(en) Standard(s) Norme(s)
94/9/EG: ATEX-Richtlinie 94/9/EC: ATEX Directive 94/9/CE: Directive ATEX	EN 60079-0: 2012 EN 60079-1: 2007 EN 60079-7: 2007 EN 60079-31:2009
Kennzeichnung, marking, marquage:	 II 2 G Ex d e IIC T. Gb II 2 D Ex tb IIIC T. Db CE 0158
EG-Baumusterprüfbescheinigung: EC Type Examination Certificate: Attestation d'examen CE de type:	LCIE 02 ATEX 6062 X (Laboratoire Central des Industries Electriques, 33, avenue du Général Leclerc 92266 Fontenay-aux-Roses, France)
2004/108/EG: EMV-Richtlinie 2004/108/EC: EMC Directive 2004/108/CE: Directive CEM	EN 55011:2007 + A2:2007 EN 55015:2006 + A1:2007 + A2:2009 EN 61547:1995 + A1: 2000 EN 61326-1: 2006 ETSI EN 301489-17: 2008
2011/65/EU: RoHS-Richtlinie 2011/65/EU: RoHS Directive 2011/65/UE: Directive RoHS	EN 50581:2012

Waldenburg, 04.11.2013

Ort und Datum
Place and date
Lieu et date

i.V.

C. Brenner
Leiter Entwicklung Leuchten & Signalgeräte
Director R&D Lighting & Signaling devices
Directeur R&D Eclairage & Appareils de signalisation

i.V.

J.-P. Rückgauer
Leiter Qualitätsmanagement
Director Quality Management
Directeur Assurance de Qualité

F-4174-601 01/2011 STLAZ

6161601020 -03

